

+

(entspricht 1)

(entspricht 0)



Abbildung 13.K2
 Relais mit Arbeitskontakt und solche mit Ruhekontakt sowie Lampe als Legeplättchen. Bitte bei Bedarf mehrfach kopieren!

Abbildung 13.K3
Quadrologic-Bauteile
Leitungen und Co



Abbildung 13.K4
Quadrologic-Bauteile
Gatter

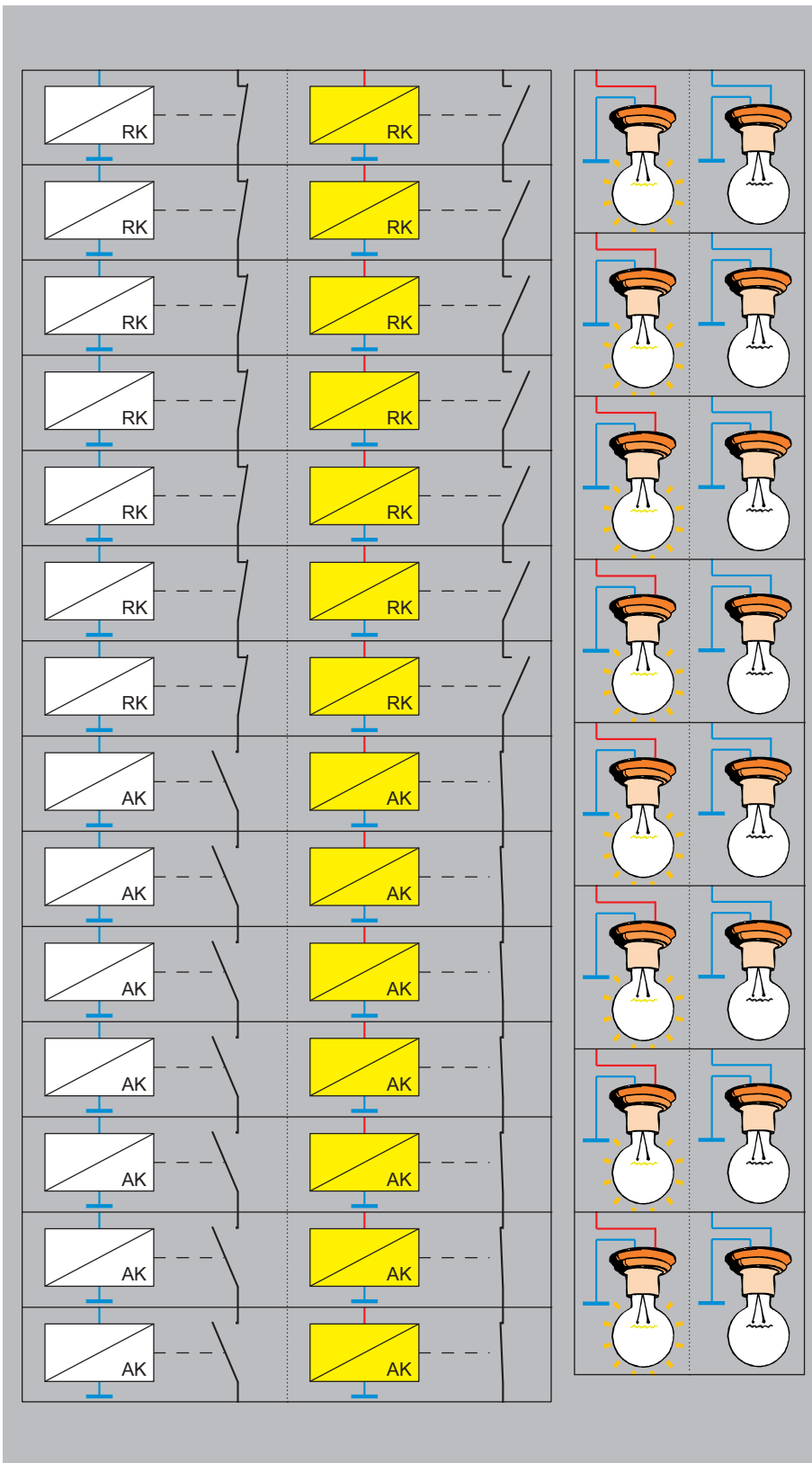

Abbildung 13.K5
 Quadrologic-Bauteile
 Ein- und Ausgangssignale

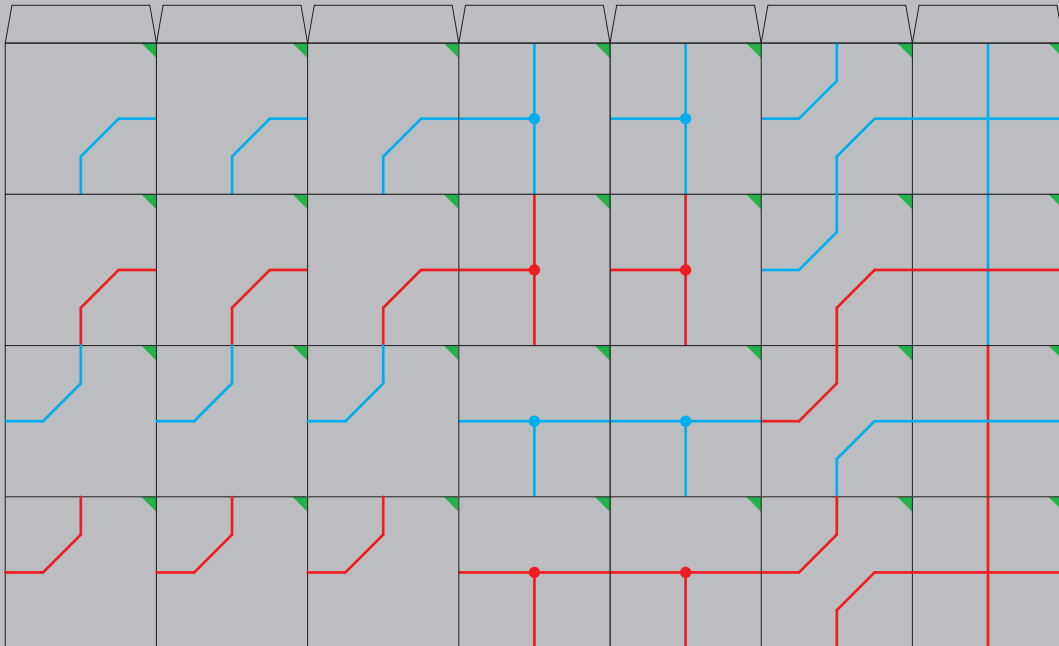
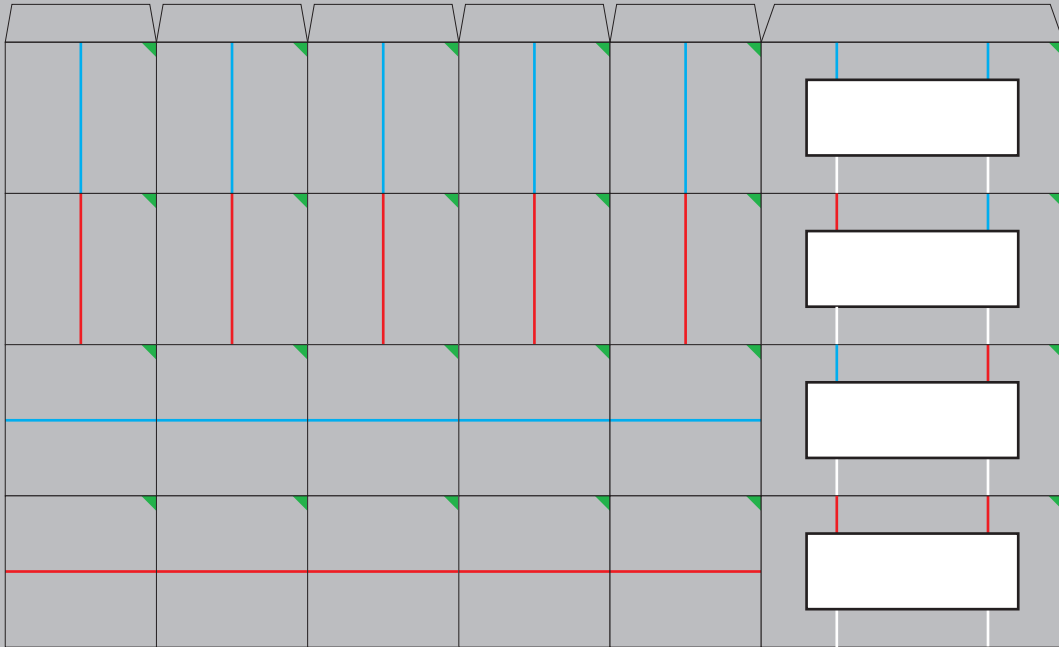
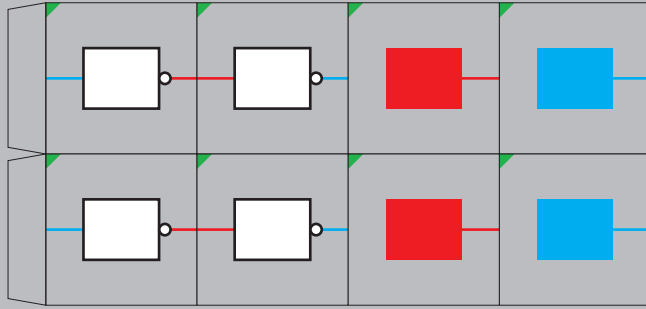

Abbildung 13.K6
Quadrologic-Bauteile
Blanko, Ein- und Ausgänge

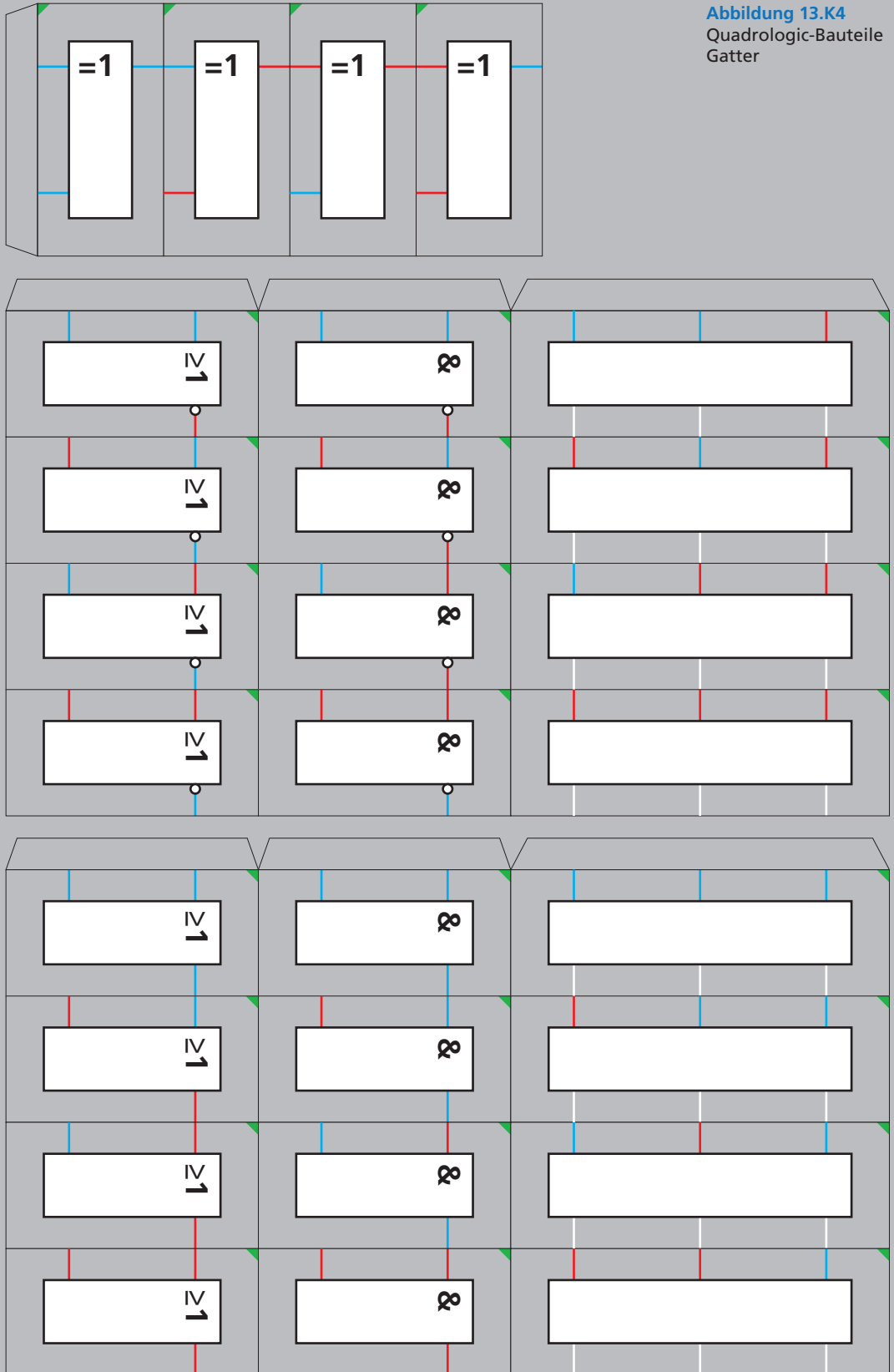

Abbildung 14.K1
 Quadrologic-Bauteile
 für Rückkopplung, weitere
 Ein- und Ausgänge

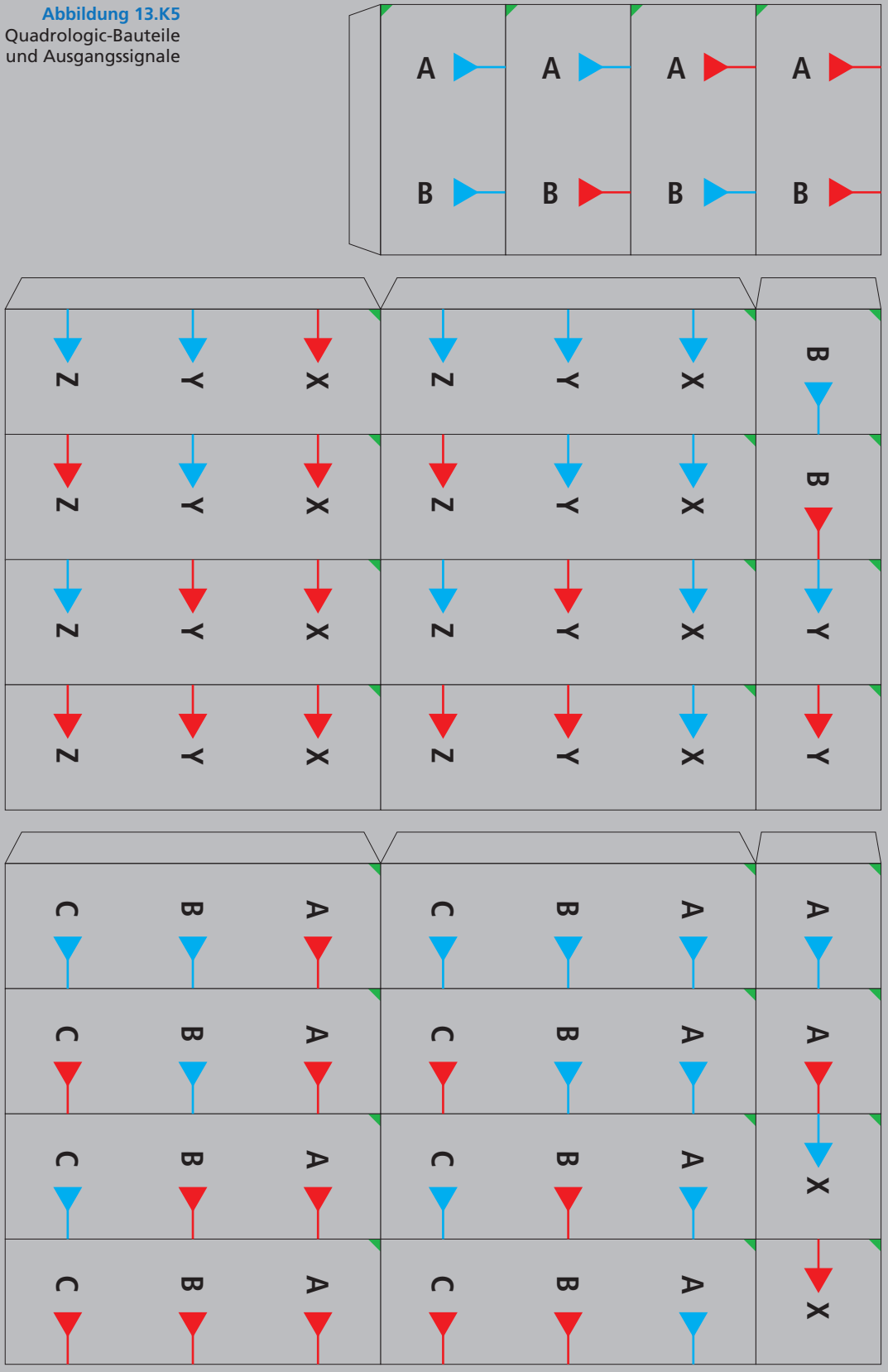
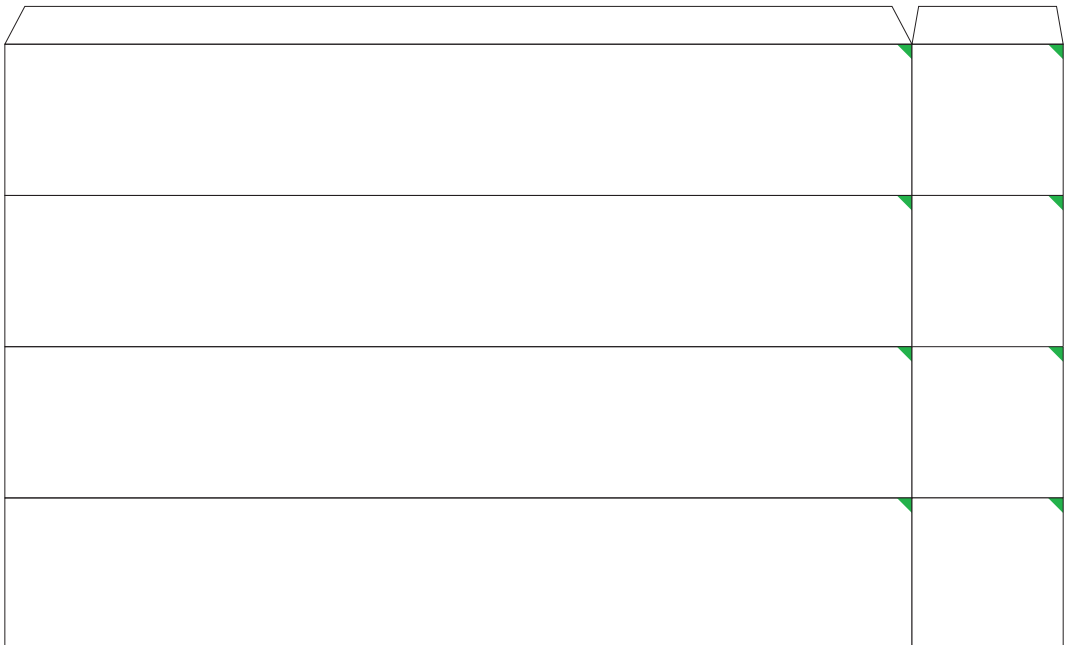
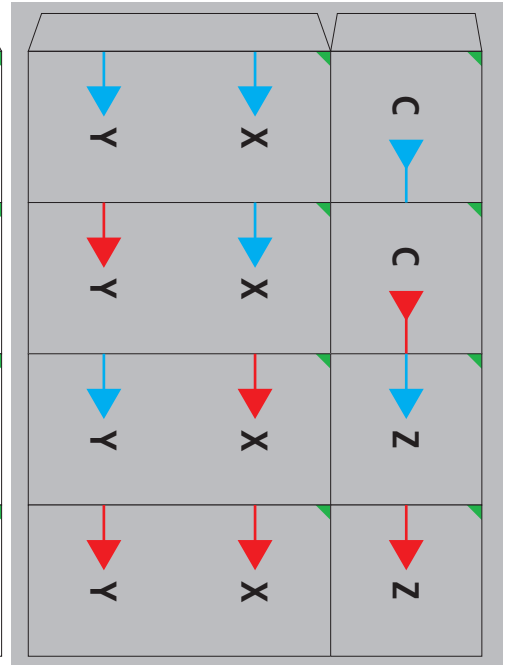
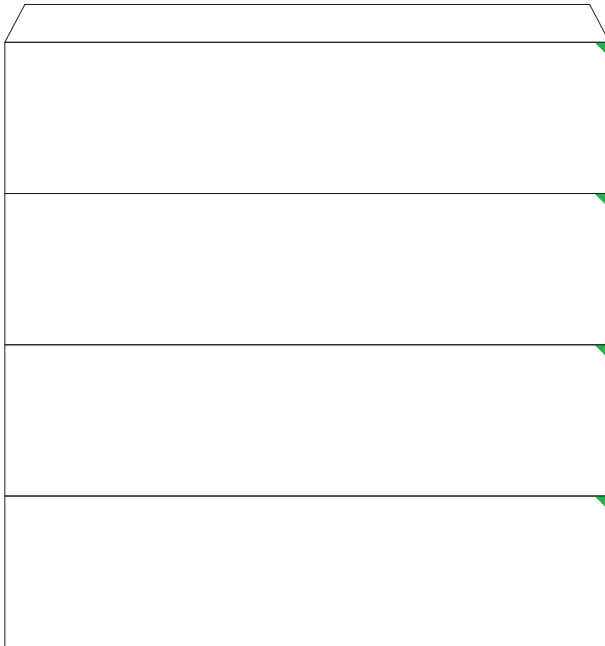
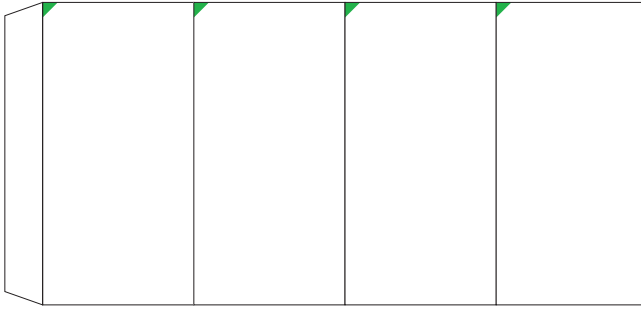